

# Reggi piano per spessore 18

## ART. 268 Supporto per spessore 18

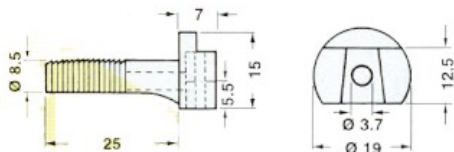

ART.	Finitura	PZ. Conf.
SU 268 CO	Nero	5000

## ART.261 Staffa per spessore 18

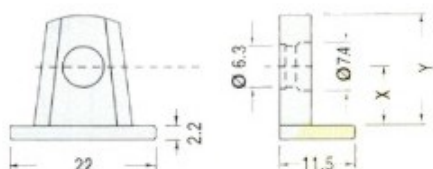
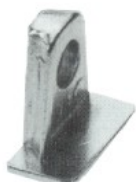

ART.	Y mm	X mm	Finitura	PZ. Conf.
ST 261 NI	15	9	Nichelato	2500
ST 261 BR	15	9	Bronzato	2500

# Reggi piano per spessore 25

## ART. 241 Supporto per spessore 25-28-30

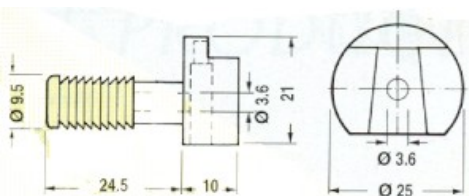

ART.	Finitura	PZ. Conf.
SU 241 CO	Nero	2500

## ART.243 Staffa per spessore 25

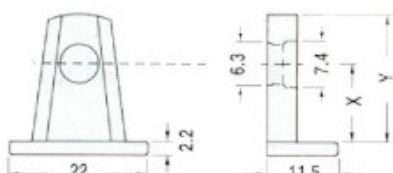
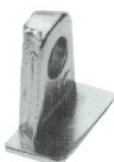

ART.	Y mm	X mm	Finitura	PZ. Conf.
ST 243 NI	19,7	12,5	Nichelato	2000
ST 243 BR	19,7	12,5	Bronzato	2000

## ART.277 Chiodo per supporto



ART.	Finitura	PZ. Conf.
CH 277 ZI	Zincato	10000

## ART.234 -2 Eurovite

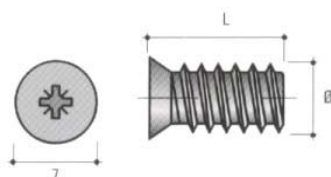

ART.	Ø mm	L mm	Finitura	PZ. Conf.
VI6311ZI	6,3	11	Zincato	1/2000
VI6313ZI	6,3	13	Zincato	1/2000
VI6315ZI	6,3	15	Zincato	1/2000

## ART. REGGIPIANO TAB

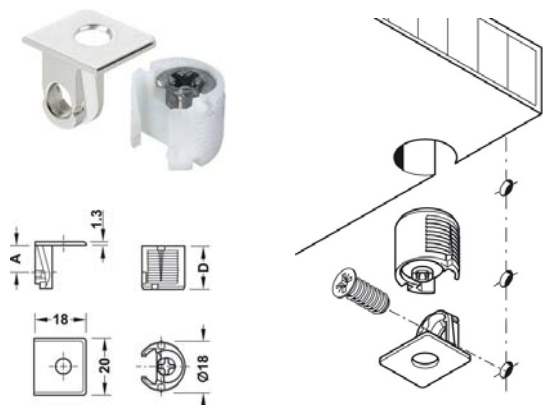

ART.	Per spessore	A mm	D mm	Finitura	Pz. conf
SU536CO	16	-	13	Bianco	1/100
SU554CO	19	-	15	Nero	1/100
SU572CO	23	-	17	Nocciola	1/100
SU590CO	29	-	20	Marrone	1/100
ST538NI	16	8	-	Nichelata	1/100
ST556NI	19	9,5	-	Nichelata	1/100
ST574NI	23	11,5	-	Nichelata	1/100
ST592NI	29	14,5	-	Nichelata	1/100

## ART. REGGIPIANO KERALA A SLITTA

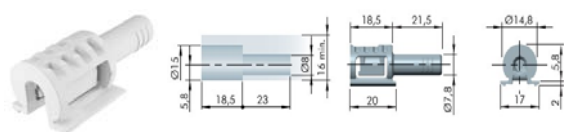

ART.	Per spessore	Diametro perno 5 mm	Finitura	Pz. conf
RP120010	MINIMO 16	-	Grigio	1/100

## ART. REGGIPIANO SPRING A MOLLA

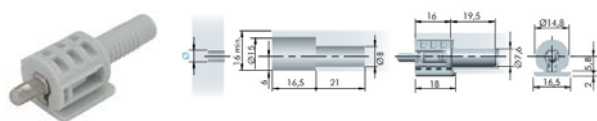

ART.	Per spessore	Diametro perno 5 mm	Finitura	Pz. conf
RP108020	MINIMO 16	-	Grigio	1/100

## ART. REGGIPIANO A VITE



ART.	Finitura	Larghezza	PZ. Conf.
GI708BI	Bianco	18	1-100
GI155MA	Marrone	18	1-100
GI404BE	Beige	18	1-100
GI710BI	Bianco	44	1-100
GI112MA	Marrone	44	1-100
GI425BE	Beige	44	1-100

MINI SINGOLO

DOPPIO 4 FORI

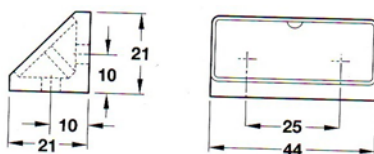
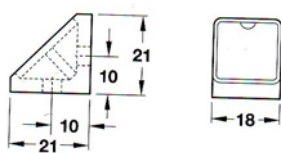





## ART.75

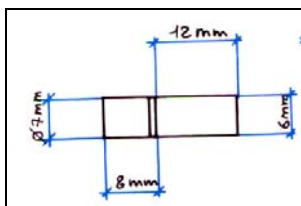

Materiale: Ottone

ART.	Finitura
RP75OL	Ottone lucido
RP75ON	Ottone nichelato

## ART.74 B

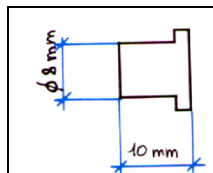

Disponibile anche senza bordo.  
Materiale: Acciaio

ART.	Finitura
BU74BOT	Ottone lucido
BU74BOB	Ottone bronzato
BU74BON	Ottone nichelato

## ART.619

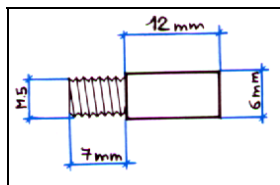

Materiale: Ottone

ART.	Finitura
RP619OL	Ottone lucido
RP619OB	Ottone bronzato
RP619ON	Ottone nichelato

## ART.620

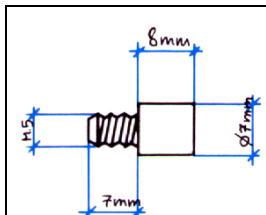

Materiale: Ottone

ART.	Finitura
RP620OL	Ottone lucido
RP620OB	Ottone bronzato
RP620ON	Ottone nichelato

## ART.621

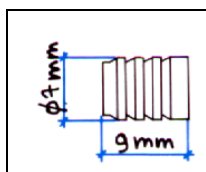

Materiale: Ottone

ART.	Finitura
BU621OL	Ottone lucido
BU621ON	Ottone nichelato

## ART.941

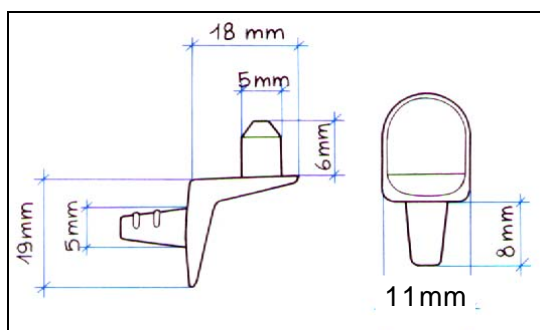

ART.	Finitura
RP941NI	Nichelato
RP942NI	Nichelato
RP943NI	Nichelato

Materiale: Zama

## ART.942



## ART.943



# Reggi mensola

## Tassello invisibile Reggi mensola

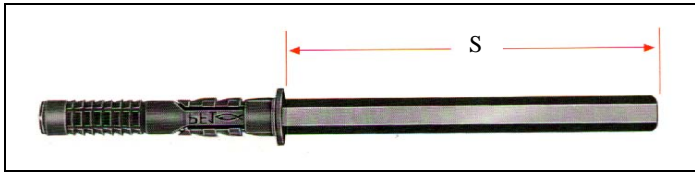

Solo Tassello

ART.	FORO Muro-Mens.	Confezione PZ	CODICE
TAPFM8	8	50	
TAPFM10	10		

ART.	FORO Muro-Mens.	S	Carico Max Kg	Confezione PZ
RM870	8	70	/	20
RM10100	10	100	/	
RM10150	10	150	/	
RM14120	14	120	36	
RM14145	14	145	30	
RM14170	14	170	20	
RM14250	14	250	/	
RM14300	14	300	/	

Tassello in Nylon - Perno esagonale in acciai Tropicale

## Reggi mensola invisibile 450P

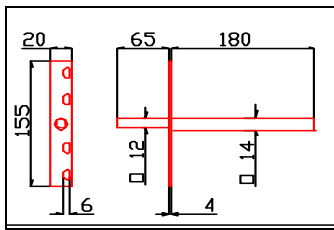
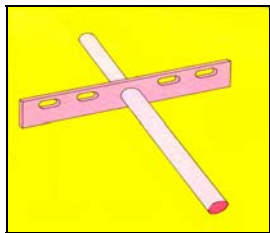

ART.	Carico Max Kg	Finitura	Confezione PZ
RM450P200CO	/	Vern. Nero	100

Materiale = Acciaio

## Reggi mensola nervata

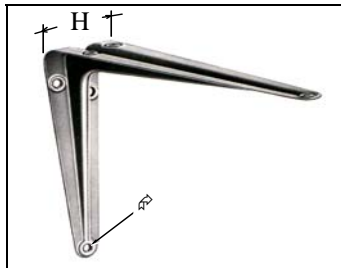

ART.	Dimensioni mm	Carico Max Kg	Finitura	Confezione PZ
RM150200CO	150 x 200	/	Vern. Bianca	24
RM200250CO	200 x 250	/		
RM250300CO	250 x 300	/		
RM300350CO	300 x 350	/		

Materiale = Lamiera di acciaio spessore 1 mm

## Reggi mensola Pesante Tondino



Larghezza = 30 mm

Spessore = 5 mm

VERNICIATA BIANCA = BI

VERNICIATA ALLUMINIO = AR

ART.	Dimensioni mm	Pz. Conf	Finitura		
			Nikel satin	Vern.Allumi	Vern.Bianco
RMTO120NS	13x13	1/12	+		
RMTO180NS	17x17	1/12	+		
RMTO240NS	23x23	1/12	+		
RMTO300 - -	300x210	1/12		+	+
RMTO400 - -	400x290	1/12		+	+
RMTO500 - -	500x380	1/12		+	+

## Reggi mensola Leggera - Pesante

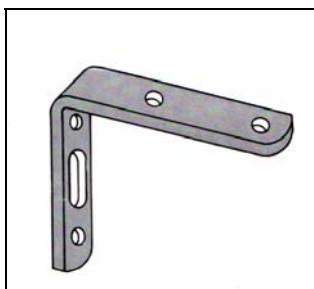

ART.	Dimensioni mm	Finitura	Conf.
RM2710ZI	60x100	Ferro zincato	1/40
RM2812ZI	70x120	Ferro zincato	1/40
RM2915ZI	70x150	Ferro zincato	1/40
RM3020ZI	70x200	Ferro zincato	1/40

Larghezza = 20 mm Spessore = 4 mm

## Reggi mensola per ripostigli 542



ART.	Dimensioni mm	Carico Max Kg	Finitura	Confezione PZ
RM542300CO	155 x 300	/	Bianco	6
RM542300TR	155 x 300	/	Tropicale	
RM542400CO	205 x 400	/	Bianco	
RM542400TR	205 x 400	/	Tropicale	
RM542500CO	300 x 500	/	Bianco	
RM542500TR	300 x 500	/	Tropicale	

Lamiera di acciaio sp. 2 mm

## Reggi mensola Pieghevole 188



ART.	Dimensioni mm	Carico Max Kg	Finitura	PZ. Conf.
RM18830BI	300 x 300	25	Bianco	1/2
RM18840BI	400 x 400		Bianco	1/2
RM18830NE	300x300		Nera	1/2

Lamiera di acciaio sp. 2 mm

## Reggi mensola Pieghevole 546



ART.	Dimensioni mm	Carico Max Kg	Finitura	Confezione PZ
RM546150TR	63 x 154	/	Tropicale	1/6
RM546220TR	63X224		Tropicale	1/6
RM546280TR	63X284		Tropicale	1/6

Lamiera di acciaio sp. 1,5 mm

## Reggi mensola Pieghevole 191



ART.	Dimensioni mm	Carico Max Kg	Finitura	Confezione PZ
RM191TGBI	75 x 350	30	Bianca	2

Lamiera di acciaio sp. 2 - 3 mm

## Reggi mensola Pieghevole PESANTE CON FERMO INCLINATO A 70° - 80° - 90°

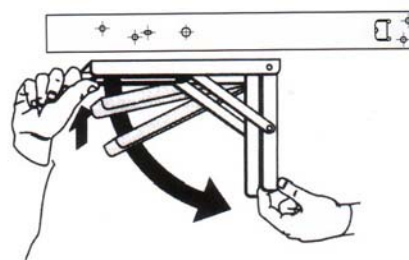
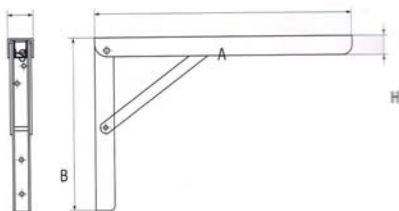

ART.	Dimensioni mm	A	B	H	Finitura	Confezione PZ	CODICE
RM253430BI	63 x 154	300	200	30	Bianco	1 / 4	1,66
RM253440BI	63X224	400	272	36	Bianco	1 / 4	1,84

## Reggimensola con carter in plastica 300

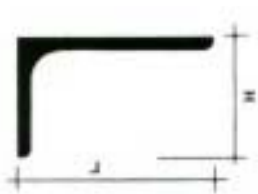

ART.	L mm	H mm	Finitura
<b>RM300A - -</b>	148	234	BIANCO - NERO FRASSINO OLMO MARRONE
<b>RM300B - -</b>	115	186	
<b>RM300C - -</b>	85	118	

Materiale = Lamiera di acciaio verniciata + involucro in ABS colorato

BIANCO = BI  
NERO = NE  
FRASSINO = FR  
OLMO = OL  
MARRONE = MA

## Reggi mensola RM TRIO



ART.	Cm	Materiale	Grigio argento	Cromo	Opalin o celeste
<b>RMTR - -</b>	A=15	Policarbonato	+	+	+
<b>RMTR - -</b>	B=20		+	+	+

## Reggi mensola RM CRISTAL

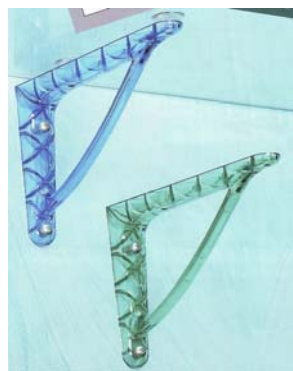

ART.	Cm	Materiale	Opalino trasparente	Opalin o verde	Opalin o azzurro
<b>RMCR A - -</b>	A=12	Policarbonato	+	+	+
<b>RMCR B - -</b>	B=18		+	+	+
<b>RMCR C - -</b>	C=24		+	+	+

CROMO = NI  
Grigio argento = AR  
Opalino azzurro = AZ  
Opalino celeste = CE  
Opalino verde = VE  
Opalino trasparente = TR







### Reggi mensola RM ANT



ART.	Dimensioni cm	Mat.	Finiture		
			Arte povera	Nero micace	Ramata
<b>RMRMANTA - -</b>	A=15x12	Ferro battuto	+	+	+
<b>RMRMANTB - -</b>	B=20x15		+	+	+
<b>RMRMANTC - -</b>	C=25x17		+	+	+
<b>RMRMANTD - -</b>	D=35x20		+	+	

### Reggi mensola RM TV



ART.	Dimensioni cm	Mat.	Finiture	
			Bianca	Verniciato alluminio
<b>RMTV24 - -</b>	24x18	Ferro	+	+
<b>RMTV30 - -</b>	30x20		+	+
<b>RMTV40 - -</b>	40x24		+	+

### Reggi mensola BAROCCO



ART.	Dimensioni cm	Mat.	Finiture	
			Ottone antico	Rame antico
<b>RMBAA - -</b>	A=12x9	Ferro	+	+
<b>RMBAB - -</b>	B=18x14		+	+
<b>RMBAC - -</b>	C=24x16		+	+

### LEGENDA

ARTE POVERA	=BR
NERO MICACE	= FB
RAMATA – RAMATA ANTICO	=RA
BIANCA	= BI
VERNICIATO ALLUMINIO	= AR
OTTONE ANTICO	= OT

## Reggi mensola a sospensione 400

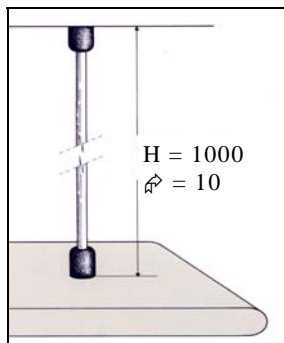

ART.	Finitura		Conf. PZ
RM400100NI	Cromo		1
RM400100OL	Ottone lucido		
RM400100BI	Bianco		
RM400100NS	Nikel satinato		

Materiale = Tondino di Acciaio con borchie in plastica nera.

# Reggi cristalli

## ART.617

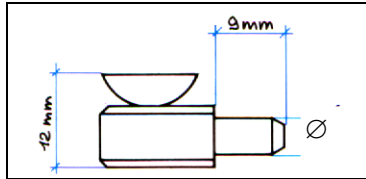

## ART.618

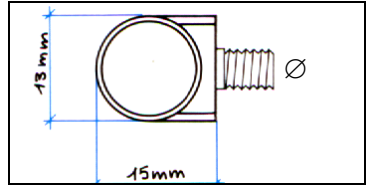

## ART.138

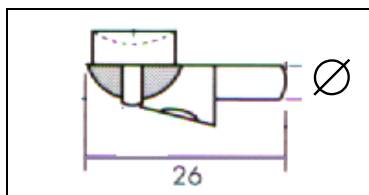

## ART.472

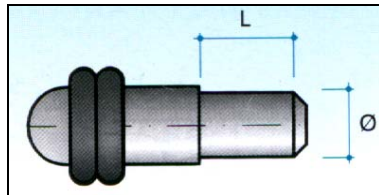

## ART.2 SA

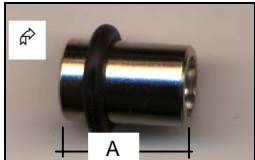

## ART.Vite 1SA

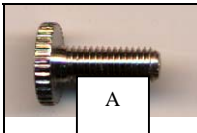

Materiale -  
Ottone

## ART. 1 SA



Con foro passante

## ART.1560



ART	Ø-M mm	Finitura	Euro €
RC617CO	5	Nero/Bianco	
RC618CO	5	Nero/Bianco	

Materiale - Gomma

ART	Ø mm	Finitura	Euro €
RC138NI	5	Nichelato	
RC138BR	5	Bronzato	

Materiale - Zama

ART	L mm	Ø mm	Finitura	Euro €
RC472NI	8	5	Nichelata	

Materiale - Ferro

ART	Ø-M mm	A mm	Finitura	Euro €
RC2SANI	12	17	Nichelato	
VI1SANI	5 MA	13	Nichelato	

ART	Ø mm	L mm	Finitura	Euro €
RC1SAOL	12	15	Oro lucido	
RC1SANI	12	15	Nichelato	
RC1SANS	12	15	Cromo satinato	

ART	Ø mm	A mm	Finitura	Euro €
RC1560OL	11	22	Oro lucido	
RC1560ON	11	22	Cromo lucido	
RC1560ONS	11	22	Cromo satinato	

MATERIALE : OTTONE

### ART.3302



ART.	Per spessore vetro mm	L x H x Pd.	Finitura	PZ.Conf.
RC3302COT	8.5	18x17x15	Oro Lucido	100
RC3302CNI	8.5	18x17x15	Cromo lucido	100
RC3302CNS	8.5	18X17X15	Nikel sat.luc.	100
RC3302CBR	8.5	18x17x15	Bronzo	100
RC3302DCS	6.5	18x17x15	Cromo satinato	100

### ART.RMC6



Materiale - Zama

ART.	Per spessore vetro mm	L x H x Pd.	Finitura	PZ.Conf.
RCRMC6OT	2/10	20x21x28	Oro lucido	20
RCRMC6NI	2/10	20x21x28	Cromo lucido	20
RCRMC6NS	2/10	20x21x28	Nichel.satinato	20

### ART.RMC4



Materiale - Zama

ART.	Per spessore vetro mm	L x H x Pd.	Finitura	PZ.Conf.
RCRMC4BO	8-12	50X32X33	Bagno oro	12
RCRMC4NI	8-12	50X32X33	Cromo lucido	12
RCRMC4NS	8-12	50X32X33	Nichel satinato	12

### ART.RMC5



Materiale -Zama.

ART.	Per spessore vetro mm	L x H x Pd.	Finitura	PZ.Conf.
RCRM5COT	2/8	50x30x27	Oro lucido	12
RCRM5CNI	2/8	50x30x27	Cromo luido	12
RCRM5CNS	2/8	50x30x27	Nichel Sat.	12
RCRM5CBR	2/8	50x30x27	Bronzato	12

### ART.3309



Puo' essere utilizzato sia per mensole in vetro che in legno.  
Portata max kg 25 art.3309 A  
Portata max kg 6 art.3309 B

ART.	Per spessore vetro mm	L x H x Pd.	Finitura	PZ.Conf.
RC3309ANS	5/27	70x42x38	Nikel sat.luc.	2
RC3309ACS	5/27	70x42x38	Cromo opaco	2
RC3309BNI	5/10	35x24x25	Cromo lucido	20
RC3309BNS	5/10	35x24x25	Nichel satinato	20
RC3309BCS	5/10	35x24x25	Cromo satinato	20



## ART.BANOLINO



Materiale - Zama

ART.	Per spessore vetro mm	L x H x Pd.	Finitura	PZ.Conf.
<b>RCBLOT</b>	4-18	26X50X28	Oro Lucido	1/12
<b>RCBLNI</b>	4-18	26X50X28	Cromo Lucido	1/12
<b>RCBLNS</b>	4-18	26X50X28	Nikel satinato	1/12
<b>RCBLCS</b>	4-18	26X50X28	Cromo satinato	1/12

## ART.BANO



Materiale - Zama.

ART.	Per spessore vetro mm	L x H x Pd.	Finitura	PZ.Conf.
<b>RCBAOT</b>	5-25	41x60x41	Oro lucido	1/8
<b>RCBANI</b>	5-25	41x60x41	Cromo lucido	1/8
<b>RCBANS</b>	5-25	41x60x41	Nick.sat.	1/8
<b>RCBACS</b>	5-25	41x60x41	Cromo satinato	1/8

## ART.CUCALE



ART.	Per spessore vetro mm	L x H x Pd.	Finitura	PZ.Conf.
<b>RCCUBO</b>	6-30	40x62x70	Bagno oro	2
<b>RCCUNI</b>	6-30	40x62x70	Cromo lucido	2
<b>RCCUNS</b>	6-30	40x62x70	Nick.satinato	2

Materiale - Zama.

## ART. RM 10



ART.	Per spessore vetro mm	L x H x Pd.	Finitura	PZ.Conf.
<b>RMRM10ANS</b>	4-32	40x90x106	Nick.sat.	2
<b>RMRM10ANI</b>	4-32	40x90x106	Cromo lucido	2
<b>RMRM10BNS</b>	4-18	29x28x75	Nick.sat.	2



