

# Pomi fissi

## ART. 31060 inox



Pomo FISSO mm 50 x 50  
modello 31060

Ditta : COTTALI

completo di piastra di fissaggio

Finitura: INOX

CODICE	Diametro base mm	Dimensioni impugnatura L x L x PR	Altezza mm	Finitura
<b>PO31060IN</b>	50 x 50	50 x 50 x 20	56	Inox

## ART. 3202017



Cromo satinato  
Materiale: OTTONE



Cromo lucido



Ottone lucido

Pomo FISSO  
mm 50 x 50  
Ditta : COTTALI

CODICE	Diametro base mm	Dimensioni impugnatura L x L x PR	Altezza mm	Finitura
<b>PO3202017CS</b>	45 x 45	50 x 50 x 25	69	Cromo satinato
<b>PO3202017ON</b>	45 x 45	50 x 50 x 25	69	Cromo lucido
<b>PO3202017OL</b>	45 x 45	50 x 50 x 25	69	Ottone lucido

## ART. 32045



Pomo FISSO diam. mm 63  
Ditta : COTTALI  
completo di piastra di fissaggio  
Materiale: OTTONE

CODICE	Diametro base mm	Diametro pomo mm	Altezza mm	Finitura
<b>PO3204517OCS</b>	48	63	70	Cromo satinato
<b>PO3204517OON</b>	48	63	70	Cromo lucido
<b>PO3204517OOB</b>	48	63	70	Bronzo graffiato

# Pomi fissi

## ART. M84/42 K

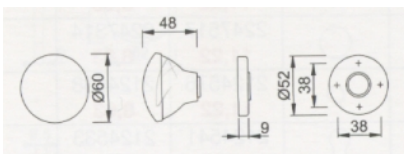

**Resista®**

10 Jahre Garantie auf die Oberfläche  
10 years' surface guarantee  
10 anni di garanzia sulla superficie  
10 ans de garantie sur la surface  
10 años de garantía sobre la superficie

Pomo FISSO mm 60 Ditta : HOPPE

completo di piastra di fissaggio

Materiale: OTTONE

CODICE	Diametro base mm	Diametro pomo mm	Altezza mm	Finitura
<b>POM8442KOCS</b>	52	60	57	Cromo satinato
<b>POM8442KOL</b>	52	60	57	Oro lucido

## ART. M84H/42 K

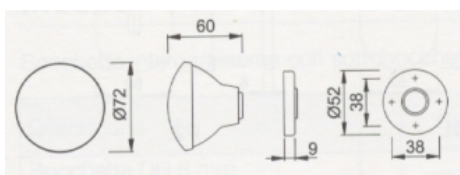

**Resista®**

10 Jahre Garantie auf die Oberfläche  
10 years' surface guarantee  
10 anni di garanzia sulla superficie  
10 ans de garantie sur la surface  
10 años de garantía sobre la superficie

Pomo FISSO diametro 72 Ditta : HOPPE

completo di piastra di fissaggio

Materiale: OTTONE

CODICE	Diametro base mm	Diametro pomo mm	Altezza mm	Finitura
<b>POM84H42KOCS</b>	52	72	69	Cromo satinato
<b>POM84H42KOL</b>	52	72	69	Oro lucido

# Pomi fissi

## ART. 181



181  
mm ø 50/70

Cromo satinato

Oro PVD

Pomo FISSO mm da 50 o 70

Ditta : OMP PORRO

completo di vite passante e piastra di fissaggio (dado cieco a parte)

Materiale: OTTONE

\*Il rivestimento P.V.D. solo per finitura oro garantisce a vita la brillantezza della superficie contro usura, attacchi da agenti atmosferici e reagenti chimici

CODICE	Diametro base mm	Diametro pomo mm	Altezza mm	Finitura
<b>PO18150PVD</b>	48	50	54	Oro pvd
<b>PO18150OCS</b>	48	50	54	Cromo satinato
<b>PO18170PVD</b>	52	70	70	Oro pvd
<b>PO18170OCS</b>	52	70	70	Cromo satinato

## ART. 1560

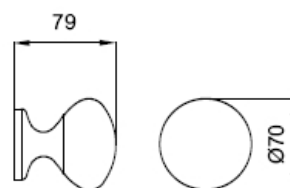

Cromo satinato

Ottone lucido

Ottone bronzato

Pomo FISSO

Ditta : MARTINELLI completo di vite passante e dado cieco

Materiale: OTTONE

CODICE	Diametro base mm	Diametro pomo mm	Altezza mm	Finitura
<b>PO1560OL</b>	52	70	79	Ottone lucido
<b>PO1560CS</b>	52	70	79	Cromo satinato
<b>PO1560OB</b>	52	70	79	Bronzo graffiato

# Pomi fissi

## ART. K1166



Cromo satinato

Cromo lucido

Zirtanio oro lucido

Pomo FISSO Ditta : VALLI & VALLI  
completo di piastra di fissaggio  
Materiale: OTTONE

CODICE	Diametro base mm	Diametro pomo mm	Altezza mm	Finitura
<b>POK1166OCS</b>	45	68	58	Cromo satinato
<b>POK1166ON</b>	45	68	58	Cromo lucido
<b>POK1166ZI</b>	45	68	58	Zirtanio Oro lucido

**ZIR** Attestato di qualità  
Si attesta che il trattamento della superficie effettuato ai nostri prodotti, denominato Zirtanio è garantito 30 anni\*.

Tale trattamento ha superato i seguenti test:

- Resistenza alla nebbia salina (1500 ore) secondo le norme ISO 9227 ASTM B117 DIN 50021
- Resistenza ai solventi secondo test MFK
- Resistenza ai prodotti specifici anticalcare
- Resistenza all'acido muriatico illimitata
- Resistenza di solidità alla luce senza alterazione secondo le norme UNI 9397

Per la pulizia consigliamo l'utilizzo di un panno inumidito con alcool.  
\*Si declina ogni responsabilità per un utilizzo negligente od improprio dei prodotti.

**ZIRTANIO 30**

La maniglia ed i suoi coordinati, ormai divenuti veri complementi d'arredo, sono comunque oggetti di uso quotidiano e quindi, inevitabilmente, soggetti ad una naturale usura. Inoltre, particolari situazioni climatiche, agenti atmosferici come salsedine e umidità o l'utilizzo in situazioni gravose, possono accelerare questi processi, intaccando lo strato protettivo e generando effetti corrosivi con conseguenze antiestetiche.

Grazie al trattamento Zirtanio, che viene effettuato sulla superficie dei prodotti, Valli&Valli garantisce la protezione per 30 anni.

## ART. 82

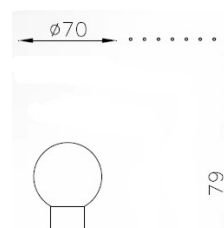
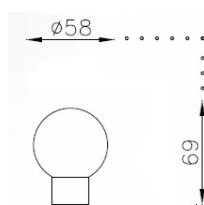

Pomo FISSO mm. 60 O 70

Ditta : MORETTINI completo di barra filettata e dado cieco

Materiale: OTTONE

CODICE	Diametro base mm	Diametro pomo mm	Altezza mm	Finitura
<b>PO8260OCS</b>	58	58	69	Cromo satinato
<b>PO8260OB</b>	58	58	69	Bronzo fumè
<b>PO8270OCS</b>	58	70	79	Cromo satinato

# Pomi fissi

## ART. 410



Nichel satinato

Cromo satinato

Ottone lucido

Bronzato

Pomo FISSO da mm 70

Ditta : LINEA CALI' completo di piastra di fissaggio

Materiale: OTTONE

CODICE	Diametro base mm	Diametro pomo mm	Altezza mm	Finitura
<b>PO41070ONS</b>	79	70	88	Nichel satinato
<b>PO41070OCS</b>	79	70	88	Cromo satinato
<b>PO41070OL</b>	79	70	88	Ottone lucido
<b>PO41070OB</b>	79	70	88	Bronzato

## ART. K1155



Cromo satinato

Ottone lucido

Pomo FISSO da mm 70 Ditta : VALLI & VALLI

Completo di piastra di fissaggio e/o vite doppio filetto con dado cieco

Materiale: OTTONE

CODICE	Diametro base mm	Diametro pomo mm	Altezza mm	Finitura
<b>POK1155OCS</b>	45	70	84	Cromo satinato
<b>POK1155OL</b>	45	70	84	Oro lucido

# Pomi fissi

## ART. 50

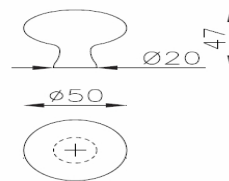

Cromo lucido

Ottone lucido

Bronzo graffiato

Pomo FISSO mm.50 Ditta : REGUITTI completo di piastra di fissaggio

Materiale: OTTONE

CODICE	Diametro base mm	Diametro pomo mm	Altezza mm	Finitura
<b>PO5050OCS</b>	43	50	47	Cromo satinato
<b>PO5050OL</b>	43	50	47	Oro lucido
<b>PO5050OB</b>	43	50	47	Bronzo

## ART. 56



Cromo satinato

Ottone lucido

Bronzato

Bronzo Anticato

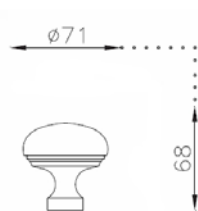
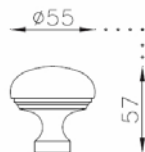

Pomo FISSO mm.60 o 75 Ditta : REGUITTI completo di piastrina di fissaggio diametro base 43mm

Materiale: OTTONE



CODICE	Diametro base mm	Diametro pomo mm	Altezza mm	Finitura
<b>PO5660OL</b>	43	55	57	Oro lucido
<b>PO5660OCS</b>	43	55	57	Cromo satinato
<b>PO5660OB</b>	43	55	57	Bronzato
<b>PO5660AN</b>	43	55	57	Bronzo antico
<b>PO5675OCS</b>	43	71	68	Cromo satinato
<b>PO5675OL</b>	43	71	68	Oro lucido
<b>PO5675OB</b>	43	71	68	Bronzato

# Pomi fissi

## ART. 1570

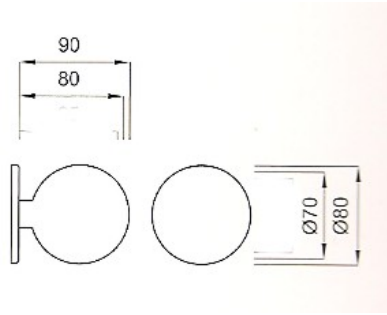

Pomo FISSO diam. mm 70 o 80

Ditta : MARTINELLI

completo di vite passante e dado cieco

Materiale: OTTONE

CODICE	Diametro base mm	Diametro pomo mm	Altezza mm	Finitura
<b>PO157070OL</b>	80	70	80	Ottone lucido
<b>PO157080OL</b>	80	80	90	Ottone lucido

## ART. 1569



1569

Pomo FISSO da mm.70

Ditta : MARTINELLI

completo di barra filettata e dado cieco

Materiale: OTTONE

CODICE	Diametro base mm	Diametro pomo mm	Altezza mm	Finitura
<b>PO156970OL</b>	80	70	66	Ottone lucido
<b>PO156970OB</b>	80	70	66	Bronzato

# Pomi fissi

## ART. 524A

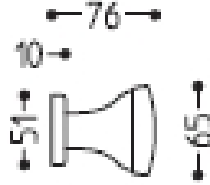

Pomo fisso diametro mm 65

Ditta : MANDELLI  
completo di piastra di fissaggio

Materiale: OTTONE  
Finitura: Brunito opaco

CODICE	Diametro base mm	Diametro pomo mm	Altezza mm	Finitura
<b>PO524AOB</b>	51	65	76	Brunito opaco

## ART. 854

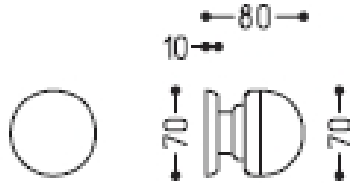

Pomo FISSO da mm 65

Ditta : MANDELLI  
completo di piastra di fissaggio

Materiale: OTTONE  
Finitura: Brunito opaco

CODICE	Diametro base mm	Diametro pomo mm	Altezza mm	Finitura
<b>PO854OB</b>	70	70	80	Brunito opaco



# Pomi fissi

## ART. 169



Bronzo satinato

Bronzo lucido

Oro satinato

Oro lucido

Argento

Pomo FISSO mm.50 o 70

Ditta : SAGUATTI

Materiale: ALLUMINIO

CODICE	Diametro base	Altezza	Finitura
<b>PO16950ABS</b>	48	60	Alluminio bronzo satinato
<b>PO16950AOS</b>	48	60	Alluminio oro satinato
<b>PO16950AOL</b>	48	60	Alluminio oro lucido
<b>PO16950AS</b>	48	60	Alluminio argento
<b>PO16970ABS</b>	68	75	Alluminio bronzo satinato
<b>PO16970ABL</b>	68	75	Alluminio bronzo lucido
<b>PO16950AOS</b>	68	75	Alluminio oro satinato
<b>PO16950AOL</b>	68	75	Alluminio oro lucido
<b>PO16950AS</b>	68	75	Alluminio argento

## ART. 175



Oro

Argento

Pomo FISSO mm.50 o 70

Ditta : SAGUATTI

Materiale: ALLUMINIO

CODICE	Diametro base	Altezza	Finitura
<b>PO17550AS</b>	48	54	Alluminio argento
<b>PO17570OS</b>	69	60	Alluminio oro
<b>PO17570AS</b>	69	60	Alluminio argento

# Pomi fissi

## ART. 53/42K

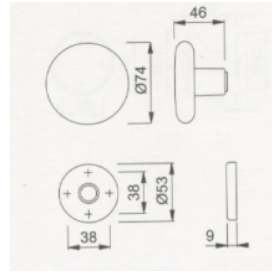

Bronzo

Oro

Argento

Pomo FISSO mm.74

Ditta : HOPPE

**Materiale: ALLUMINIO**

<b>CODICE</b>	<b>Diametro base</b>	<b>Diametro pomo</b>	<b>Altezza</b>	<b>Finitura</b>
<b>PO53SAB</b>	53	74	46	Alluminio bronzo
<b>PO53SAO</b>	53	74	46	Alluminio oro
<b>PO53SAA</b>	53	74	46	Alluminio argento

## ART. 63-75/42K

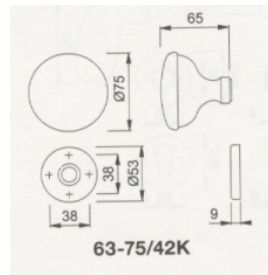

Bronzo

Argento

Pomo FISSO mm.75

Ditta : HOPPE

**Materiale: ALLUMINIO**

<b>CODICE</b>	<b>Diametro base</b>	<b>Diametro pomo</b>	<b>Altezza</b>	<b>Finitura</b>
<b>PO6375AB</b>	53	75	65	Alluminio bronzo
<b>PO6375AA</b>	53	75	65	Alluminio argento

# Pomi fissi

## ART. 869 Alluminio



Pomo FISSO mm.50 o 70

Ditta : SAGUATTI

completo di piastra di fissaggio

**Materiale: ALLUMINIO**

<b>CODICE</b>	<b>Diametro base</b>	<b>Altezza</b>	<b>Finitura</b>
<b>PO869B50NE</b>	48	60	Nero ral 9005
<b>PO869B50BI</b>	48	60	Bianco ral 9010
<b>PO869B70BI</b>	68	75	Bianco ral 9010

## ART. 669 DA 70 NYLON



Pomo FISSO mm 70

Ditta : SAGUATTI

completo di piastra di fissaggio

**Materiale: NYLON**

<b>CODICE</b>	<b>Diametro base</b>	<b>Altezza</b>	<b>Finitura</b>
<b>PO66970NE</b>	68	75	Nero ral 9005