

Paletti

ART.517 Paletto verticale a filo

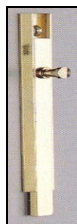

ART.	Lunghezza mm	Larghezza mm	Finitura	Pz. Conf.
PA5176OL	60	14	Lucido	50
PA5178OL	80			
PA5176OB	60		Bronzato	
PA5178OB	80			

Materiale: Ottone

ART.519 Paletto trasversale

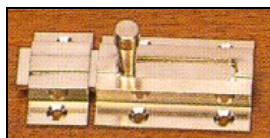

ART.	Lunghezza mm	Larghezza mm	Finitura	Pz. Conf.
PA51910OL	10	31	Ottone Lucido	1/25

Materiale: Ottone

ART.520 Paletto con bordo

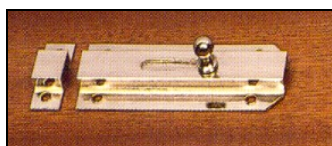

ART.	Lunghezza mm	Larghezza mm	Finitura	Pz. Conf.
PA5208OL	80+10 Tot. 90	25	Lucido	1/25
PA52010OL	100+10 Tot. 110			

ART.625 Catenaccio cannone

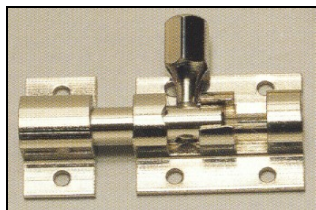

Materiale ottone

ART.	Lunghezza mm	Larghezza mm	Finitura	Pz. Conf.
PA62550OL	32+18 Tot. 50	25	Ottone lucido	1/25
PA62570OL	52+18 Tot. 70			
PA62595OL	78+18 Tot. 96			
PA625120OL	100+18 Tot. 118			
PA62550ON	32+18 Tot. 50			
PA62570ON	52+18 Tot. 70		Ottone nichelato	
PA62595ON	78+18 Tot. 96			
PA625120ON	100+18 Tot. 118			
PA62560OB				
PA62570OB	52+18 Tot. 70			
PA62595OB	78+18 Tot. 96			

ART.620 Catenaccio cannone



Materiale: Ottone

ART.	Lunghezza mm	Larghezza mm	Finitura	Pz. Conf.
PA62060ON	20 + 50 Tot 70	40	Ottone Nichelato	1/24

Paletti

ART.521 Paletto trasversale



Materiale: Ottone

ART.	Lunghezza mm	Larghezza □ mm	Finitura	Pz. Conf.
PA52160OL	23+42 Tot. 65	9	Lucido	1/25
PA52175OL	28+48 Tot. 76	10		
PA52190OL	34+57 Tot. 91	12		

ART.635/522 Paletto trasversale per tapparelle



Materiale: Ottone

ART.	Lunghezza mm	Larghezza □ mm	Finitura	Pz. Conf.
PA522MOL	56	12	Ottone lucido	1/25
PA635OL	90	14	Ottone lucido	1/25

ART.524/ AP Paletto verticale pesante



Materiale: Ottone

ART.	Lunghezza mm	Larghezza mm	Finitura	Pz. Conf.
PA524AP20OL	200	46	Ottone Lucido	1/12
PA524AP30OL	300			
PA524AP20OB	200		Ottone bronzato	
PA524AP15ON	150		Ottone nichelato	
PA524AP20ON	200		Ottone nichelato	
PA524AP30ON	300		Ottone nichelato	

ART.523/G Paletto orizzontale

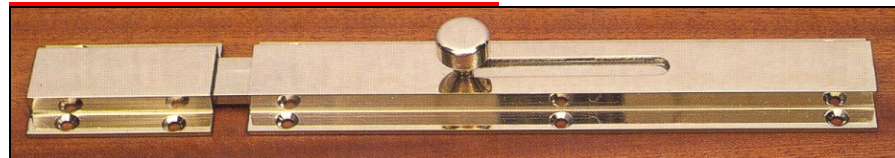

Materiale: Ottone

ART.	Lunghezza mm	Larghezza mm	Finitura	Lama	Pz. Conf.			
PA523G10OL	30 + 70 Tot.100	46	Ottone Lucido	20 x 5	1/12			
PA523G15OL	40 + 110 Tot 150							
PA523G25OL	70 + 180 Tot 250							
PA523G30OL	70 + 180 Tot 300							
PA523G15OB	40 + 110 Tot 150	Ottone bronzo	Ottone bronzo					
PA523G20OB	50 + 150 Tot 200							
PA523G25OB	70 + 180 Tot 250							
PA523G30OB	70 + 180 Tot 300							
PA523G10ON	30 + 70 Tot.100	Ottone nichelato	Ottone nichelato					
PA523G20ON	50 + 150 Tot 200							
PA52320OL	50 + 150 Tot 200					38	Ottone Lucido	15X4

Paletti

ART.4200

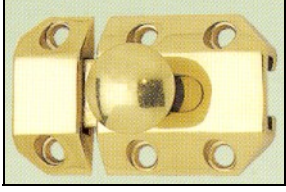

Materiale: Ottone

ART.	Lunghezza mm	Larghezza mm	Finitura	Pz. Conf.
PA420050OL	15+35 Tot. 50	34	Lucido	1/12
PA420075OL	15+60 Tot. 75			
PA4200100OL	20+80 Tot. 100			
PA4200150OL	25+125 Tot. 150			

ART.4250



Materiale: Ottone

ART.	Lunghezza mm	Larghezza mm	Finitura	Pz. Conf.
PA4250114OL	25+75 Tot. 100	22	Ottone lucido	1/12
PA4250114ON	15+60 Tot. 75		Ottone nichelato	

ART.4280



Materiale: Ottone

ART.	Lunghezza mm	Larghezza mm	Finitura	Pz. Conf.
PA4280150OCS	30+120 Tot. 150	33	Ottone cromo satinato	1/12

ART.880 Catenaccio cannone



Materiale: Ottone

ART.	Lunghezza mm	Larghezza mm	Finitura	Pz. Conf.
PA88016OL	40 + 120 Tot 160	40	Ottone lucido	1/12

Paletti

ART.585



Materiale: Ferro

ART.	Lunghezza mm	Finitura	Pz. Conf.
PA58560ZI	60	Zincato	1/24
PA58580ZI	80		
PA585100ZI	100		
PA585120ZI	120		

ART.584

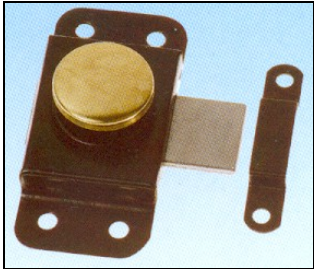

Materiale: Ferro

ART.	Lunghezza mm	Finitura	Pz. Conf.
PA58430ZI	30	Zincato	1/12

Paletti

ART.3330 Paletto a scatola con pomolo a scatto



Materiale: Ottone

ART.	Lunghezza mm	Larghezza mm	Finitura	Pz. Conf.
PA3330OL	58+16 Tot. 74	38	Oro lucido	1/10

ART.82 ART.76 Paletto trasversale

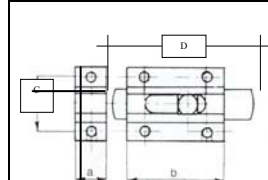
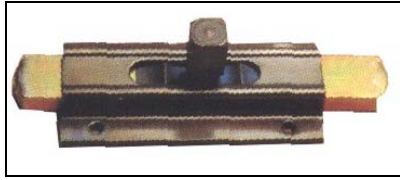

Materiale: Ferro

ART.	A mm	B mm	C mm	D mm	Finitura	Pz. Conf.
PA8280TR	15	50	38	80	Tropicalizzato	1/12
PA82110TR	30	70		110		
PA82150TR	40	90		150		
PA8280BR	15	50		80	Bronzato	
PA82110BR	30	70		110		
PA82150BR	40	90		150		
PA76214BR	13	100	45	73	Bronzo	1/8
PA7620BR	12	130		116,5	Bronzo	
PA7626BR	11	170		146	Bronzo	
PA7614ZI	13	100	45	73	Zincato	1/6
PA7620ZI	12	130	45	116,5	Zincato	1/6

ART.110 /122 Paletto portalucchetto

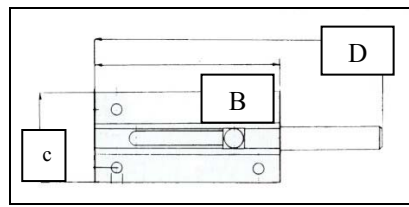
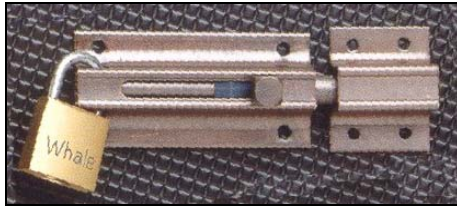

Lucchetto non compreso
Materiale: Ferro

ART.	B mm	C mm	D mm	Finitura	Pz. Conf.
PA11080TR	50	33	70	Tropicalizzato	1/12
PA110110TR	70		110		
PA110150TR	90		150		
PA11080BR	50		70	Bronzo	
PA110110BR	70		110		
PA110150BR	90		150		
PA12216TR	100		160	Tropicalizzato	
PA12221TR	130		210	Tropicalizzato	
PA12216NE	100		160	Nero	
PA12221NE	130		210	Nero	

ART.87 - 74 con incontro

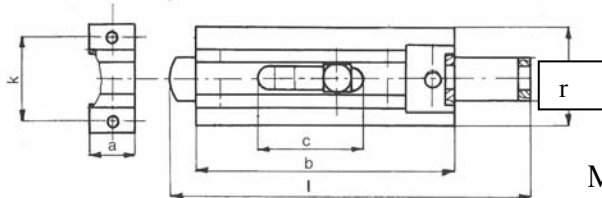
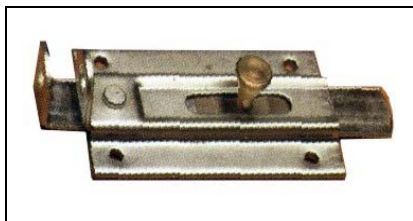

Materiale: Ferro

ART.	b mm	r mm	l mm	c mm	Finitura	Pz. Conf.
PA8710ZI	70	40	85	30	Zincata	1/12
PA7416ZI	110	43	160	50	Zincata	1/10
PA7421TR	130	50	210	70	Tropicalizzato	1/8

ART.815/816

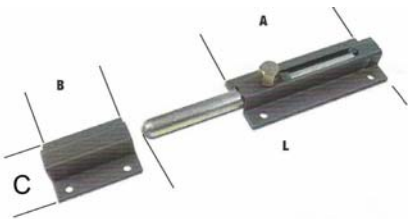

CODICE	A mm	B mm	C mm	L mm	Diametro perno mm	Finitura
PA815B07BI	50	15	34	70	9	BIANCO
PA815B11BI	70	30		110		
PA815B15BI	90	40		150		
PA815A07GR	50	15		70		GRIGIO
PA815A11GR	70	30		110		
PA815A15GR	90	40		150		
PA815G07NE	50	15	70	12	NERO	
PA815G11NE	70	30	110			
PA815G15NE	90	40	150			
PA816B16BI	100	50	41		160	BIANCO
PA816B21BI	130	60			210	
PA816A16GR	100	50			160	GRIGIO
PA816A21GR	130	60		210		
PA816G16NE	100	50		160	NERO	
PA816G21NE	130	60	210			

ART.9520223

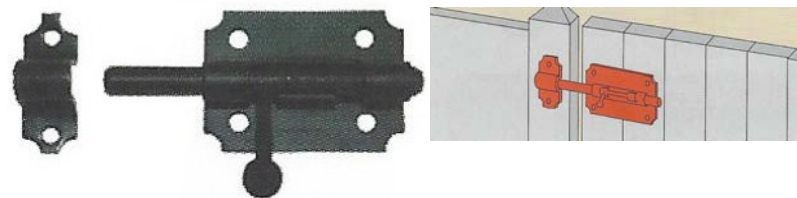

CODICE	Dimensione mm	Diametro perno mm	Finitura
PA9520223NE	80x61 + incontro 21	12	NERO

ART.9521183

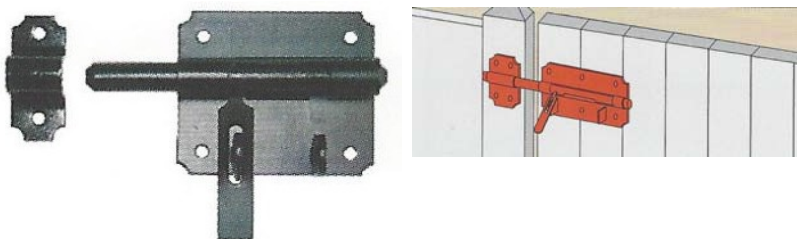

CODICE	Dimensione mm	Diametro perno mm	Finitura
PA9521183NE	100X71 + incontro 35	16	NERO

ART.22

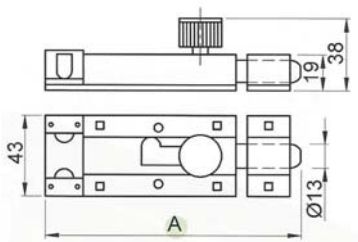

CODICE	A mm	Finitura
PA22200TR	200	Tropicale
PA22V250TR	250	Tropicale

ART.27 Catenaccio tondo

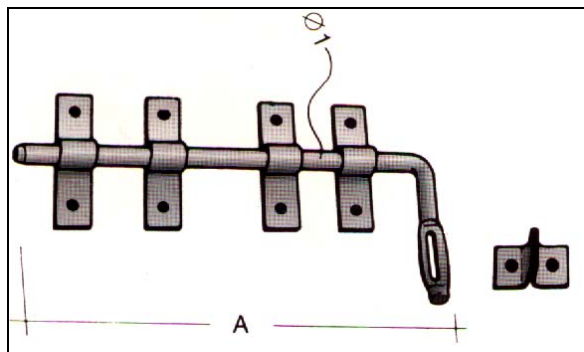

ART.	A mm	Ø mm	Finitura	PZ. Conf.
CA2720TR	200	12	Tropicalizzato	1/12
CA2725TR	250			
CA2730TR	300	14		
CA2740TR	400			
CA2750TR	500			

Materiale: Ferro

OCCHIO

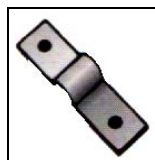

ART.	EURO
OC27TR	0.36

ART.613

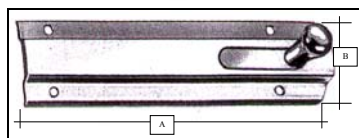

Materiale: Ferro

ART.	A mm	B mm	Finitura	PZ. Conf.
PA61320TR	200	40	Tropicalizzato	1/6
PA61330TR	300			
PA61320NE	200		Nero	
PA61330NE	300			

ART.616

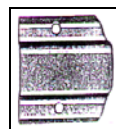

ART.	Finitura
IN616TR	Tropicalizzato
IN616NE	Nero

Incontro per art.613

Paletti

ART.262 PALETTO VERTICALE

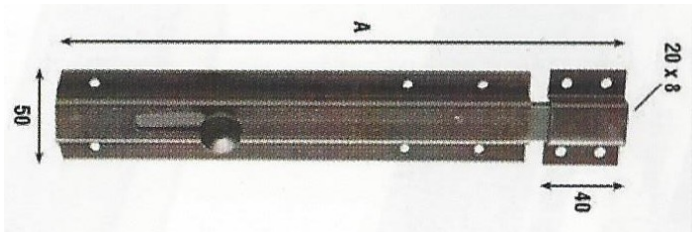

ART.	A mm	Finitura	PZ. Conf.
PA26220BR	200	Bronzato	1/10

ART.261 PALETTO VERTICALE

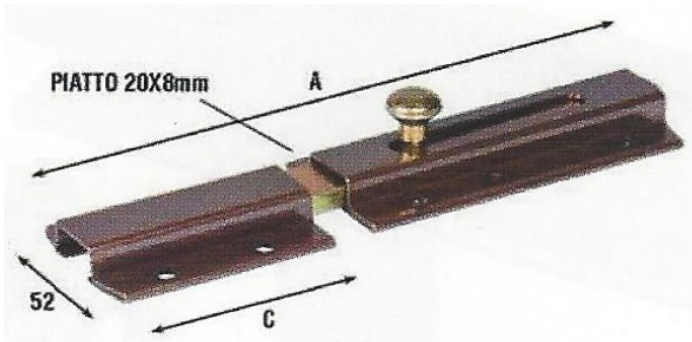

ART.	A mm	C mm	Finitura	PZ. Conf.
PA26120BR	195	74	Bronzato	1/5
PA26130BR	318	99		

Paletti

ART.1509 PALETTO VERTICALE

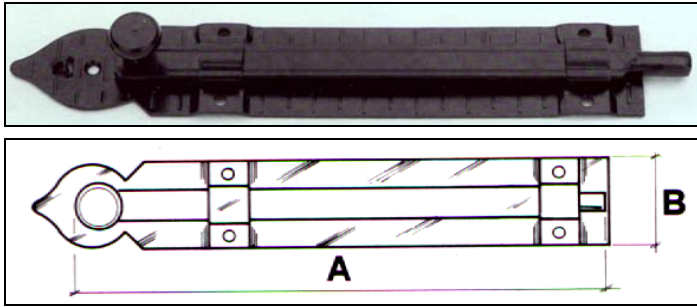

ART.	A mm	B mm	Finitura	PZ. Conf.
PA150925TR	250	47	Tropicalizzato	6
PA150940TR	400			
PA150925NE	250		Nero	
PA150940NE	400			

Materiale: Fe

Paletto verticale con **Finale tondo**

ART.1510 PALETTO TRASVERSALE

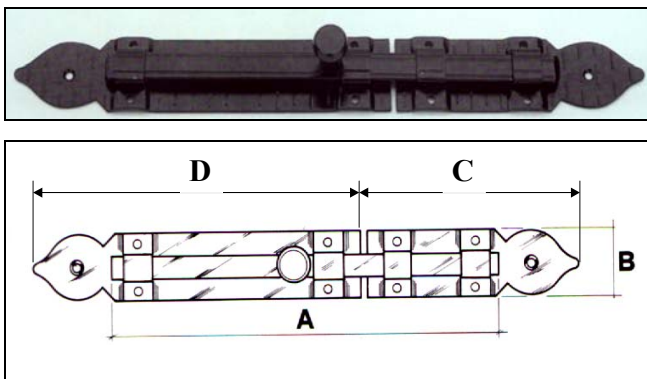

ART.	A mm	B mm	C mm	D mm	Finitura	PZ. Conf.
PA151022TR	220	47	145	210	Tropicalizzato	6
PA151030TR	300			290		
PA151022NE	220			210	Nero	
PA151030NE	300			290		

Materiale: Fe

Paletto trasversale

ART.7530 PALETTO TRASVERSALE PER PERSIANE CON ASOLA PER PASSAGGIO ASTA GARAGOLO

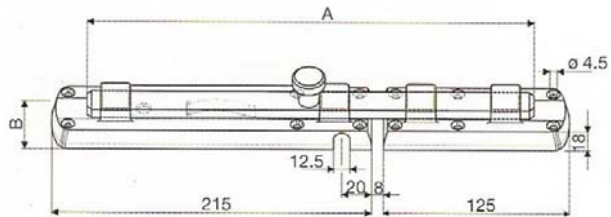
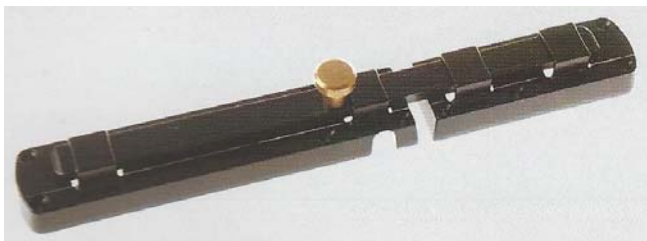

ART.	Finitura	PZ. Conf.
PA753030NE	Nero	1/12

Paletti

ART.FM 034 CATENACCIO TRASVERSALE

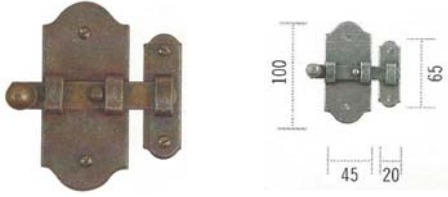

ART.	Finitura	PZ. Conf.
CAFM034FV	Ruggine	1/2

ART.FM036 CATENACCIO TRASVERSALE



ART.	Lunghezza mm	Larghezza mm	Finitura	PZ. Conf.
PAFM03630FV	300	45	Ruggine	1/2
PAFM03640FV	400	45		

ART.FM 035 CATENACCIO VERTICALE

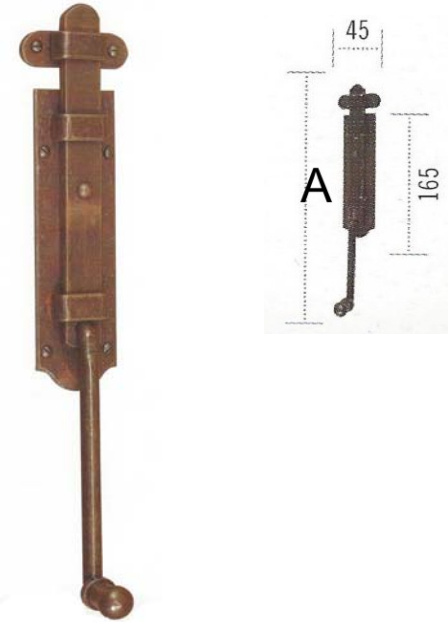

ART.	A mm	Finitura	PZ. Conf.
CAFM03530FV	300	Ruggine	1/2
CAFM03540FV	400		

Paletti a incasso

ART.300 Paletto a pulsante



ART.	Lunghezza mm	Larghezza mm	Profondità mm	Finitura	PZ. Conf.
PA30012OT	120	13,5	11,5	Ottonato	1/20
PA30015OT	150				
PA30020OT	200				
PA30025OT	250				
PA30012BR	120			Bronzato	
PA30015BR	150				
PA30020BR	200				
PA30025BR	250				

ART.320 Paletto a leva



ART.	Lunghezza mm	Larghezza mm	Profondità mm	Finitura	PZ. Conf.
PA32015OT	150	16	13	Ottonato	1/20
PA32020OT	200				
PA32025OT	250				
PA32030OT	300				
PA32040OT	400				
PA32050OT	500				
PA32015BR	150			Bronzato	
PA32020BR	200				
PA32025BR	250				
PA32030BR	300				
PA32040BR	400				
PA32050BR	500				
PA32015NI	150			Nichelato	
PA32020NI	200				
PA32025NI	250				
PA32030NI	300				
PA32040NI	400				
PA32050NI	500				
PA32015NS	150			Nichel satinato	1/20
PA32020NS	200				
PA32025NS	250				
PA32030NS	300				
PA32040NS	400				

ART.350 Paletto a leva

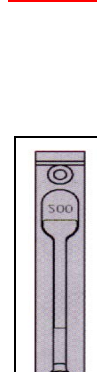

ART.	Lunghezza mm	Larghezza mm	Profondità mm	Finitura	PZ. Conf.
PA35020ZI	200	20	16	Zincato	1/20
PA35025ZI	250				
PA35030ZI	300				
PA35040ZI	400				
PA35020BR	200			Bronzato	
PA35025BR	250				
PA35030BR	300				
PA35040BR	400				

Pal 02

ART.211A

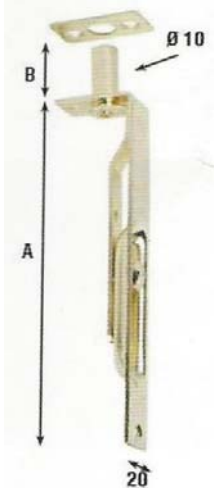

ART.	Lunghezza mm	Finitura	Pz. Conf.
PA211A15OT	15	Ottonato	1/12
PA211A20OT	20		
PA211A25OT	25		
PA211A30OT	30		

Materiale: Acciaio ottonato

ART. 1030 Paletto a 2 vie

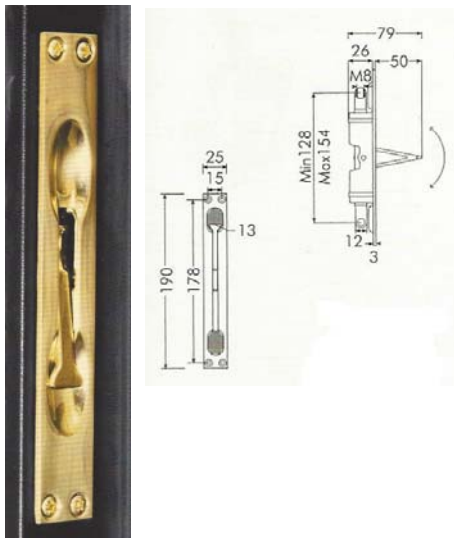

ART.	Lunghezza cm	Larghezza mm	Finitura	Pz. Conf.
CA103025OL	190	25	Ottone Lucido	1/12
CA103025ON	190	25	Ottone nichelato	1/12

Materiale: Ottone con attacchi per barre filettate MA8

ART.178



Materiale: Ottone

ART.	Lunghezza mm	Finitura	Pz. Conf.
PA17880OL	80	Lucido	1/10