

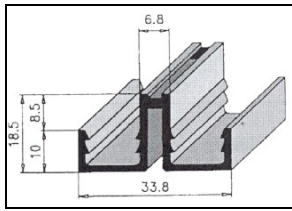

ART. 121



ART.	Lunghezza asta Mt.	Finitura
CR12125AN	2,5	All. naturale
CR1213AN	3	All. naturale

ART. 1211

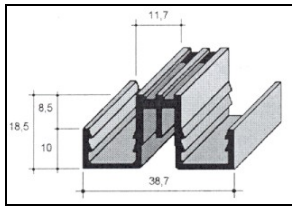

ART.	Lunghezza asta Mt.	Finitura
CR121125AN	2,5	All. naturale
CR12113AN	3	All. naturale

ART.127

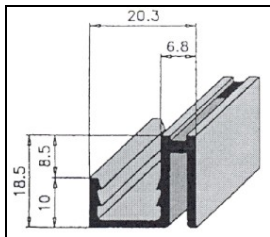

ART.	Lunghezza asta Mt.	Finitura
CR12725AN	2,5	All. naturale
CR1273AN	3	All. naturale

ART. M6

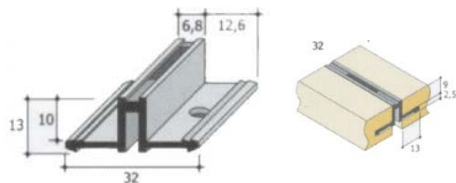

ART.	Lunghezza asta Mt.	Finitura
CRM625AN	2,5	All. naturale

ART. EFR

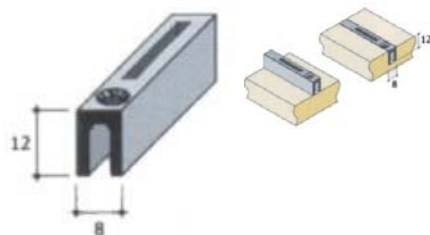

ART.	Lunghezza asta Mt.	Finitura
CREFR2013AN	2	All. naturale

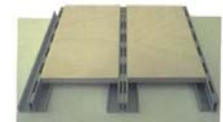

ART. CT

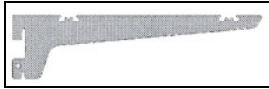

ART.	Lunghezza mm	Finitura	EURO €
RMCT15AN	150	All. naturale	
RMCT20AN	200	All. naturale	4,75
RMCT25AN	250	All. naturale	5,81
RMCT30AN	300	All. naturale	6,77
RMCT35AN	350	All. naturale	9,81
RMCT40AN	400	All. naturale	

ART. DM su ordinazione



ART.	Lunghezza mm	Finitura	EURO €
RMDM28AN	280	All. naturale	11,36
RMDN38AN	380	All. naturale	16,79

ART. DMA su ordinazione



ART.	Lunghezza mm	Finitura	EURO €
RMDMA28AN	280	All. naturale	11,36

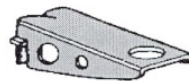
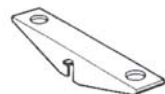

ART. A1D =DX
ART.A1G=SX
PLASTICA TRASPARENTE
CON VENTOSA

ART. A2 PLASTICA
TRASPARENTE
CON VENTOSA

ART. A1D =DX
ART.A1G=SX
FERRO ZINCATO
SENZA VENTOSA

ART. A2 FERRO
ZINCATO SENZA
VENTOSA

ART.	Descrizione	Finitura	EURO €
ATA1DTR	Cavaliere DX	Plastica trasparente	0,85
ATA1GTR	Cavaliere SX	Plastica trasparente	0,85
ATA2TR	Cavaliere DOPPIO	Plastica trasparente	1,16
ATA1DSVNS	Cavaliere DX	Ferro zincato	1,11
ATA1GSVNS	Cavaliere SX	Ferro zincato	1,11
ATA2SVNS	Cavaliere DOPPIO	Ferro zincato	1,25
ATFCR12MDAIN	Clips da 50 mm	INOX	1,09
VETR	Ventosa per reggi mensole	Trasparente	



ART. VETR
Ventosa



ART. FCR12MDA
ACCIAIO
INOSSIDABILE
Serve per il fissaggio
rimovibile del
pannello

Frasan Cremagliera

ART. 620 Cremagliera



CODICE	H Asta cm	Finitura	Pz. Conf.
CR620BI	200	Bianco	2 Aste
CR620NE	200	Nero	2 Aste
VR620NS	200	NICH. SAT	2 Aste

ART.628



CODICE	Lunghezza cm	Finitura	Pz. Conf.
RM62815BI	15	Bianco	10
RM62822BI	22	Bianco	10
RM62830BI	30	Bianco	10
RM62840BI	40	Bianco	10
RM62815NE	15	Nero	10
RM62822NE	22	Nero	10
RM62830NE	30	Nero	10
RM62840NE	40	Nero	10
RM62815NS	15	NICH. SAT	10
RM62822NS	22	NICH. SAT	10
RM62830NS	30	NICH. SAT	10
RM62840NS	40	NICH. SAT	10

ART.627



CODICE	Lunghezza cm	Finitura	Pz. Conf.
RT62730BI	15	Bianco	10

ART.626V



CODICE	Finitura	Pz. Conf.
CA626BI	Bianco	100
CA626NE	Nero	100
CA626NS	NICH. SAT	100



Cremagliera orizzontale 931

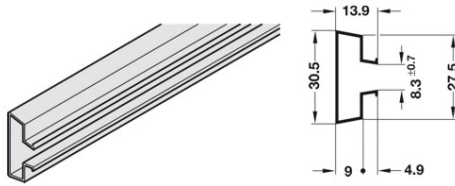

ART.	Lunghezza asta mm	Finitura
CR931AA	3100	All. naturale

Materiale alluminio

Cremagliera a muro

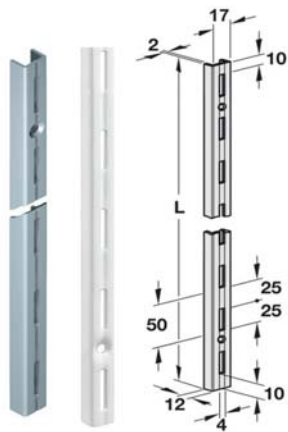

ART.	Lunghezza asta mm	Finitura
CR03620BI	1995	Bianco
CR625BI	2495	
CR620AL	1995	Grigio
CR625AL	2495	

Materiale acciaio
Finitura verniciao epossidico
Passo 50 mm

Mensola, con bordo d'avvitamento angolare

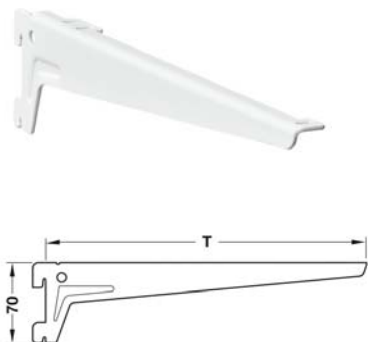

ART.	Lunghezza mm	Finitura
RM618BI	180	Bianco
RM623BI	230	
RM628BI	280	
RM633BI	330	
RM638BI	380	
RM523AL	230	Grigio
RM528AL	280	
RM533AL	330	
RM538AL	380	

Cremagliere 03

Frasan Cremagliere

ART. 1250 - 1255



CODICE	H Asta cm	Larghezza cm	Finitura	Pz. Conf.
CR1250NI	160	1,2	Nichelata	50 Aste
CR1255NI	120	2	Nichelata	50 Aste

ART.1251 - 1256



CODICE	Misura cm	Finitura	Pz. Conf.
ME1251NI	2x1	Nichelata	200
ME1256NI	3x1,5	Nichelata	200

Cremagliere a ghigliottina per ante a scorrimento verticale

ART. 4561



CODICE	H Asta cm	LxP	Finitura	Pz. Conf.
CR4561ON	610	10X5	Ottone nichelata	1/10

ART.4560



CODICE	Misura cm	Finitura	Pz. Conf.
CR4560ON	43x38	Ottone nichelata	1/10